

DUCT AND MOULD CUTTERS/ MERRY CUTTERS

SX15

< Standard type >

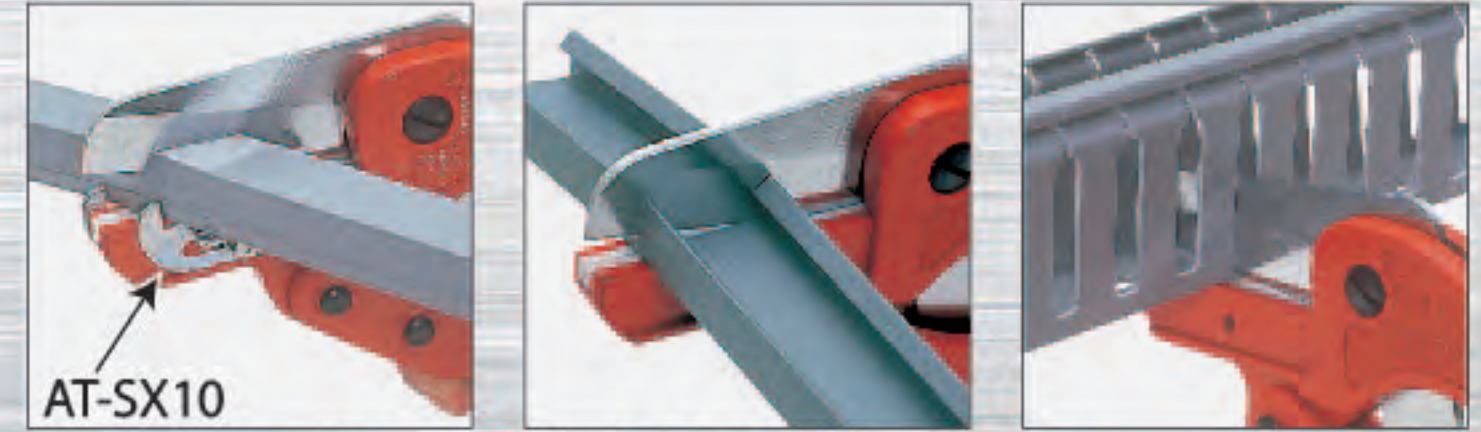

AT-SX10
Possible to cut plastic surface protector at any desired angle with an optional attachment installed.

Plastic duct and duct cover

Model	Overall length (mm)	Weight (g)	Blade length (mm)	Blade	Plastic plate
SX15	210	395	65	X15	PB-SX15-5P

SX20

< Long blade type >

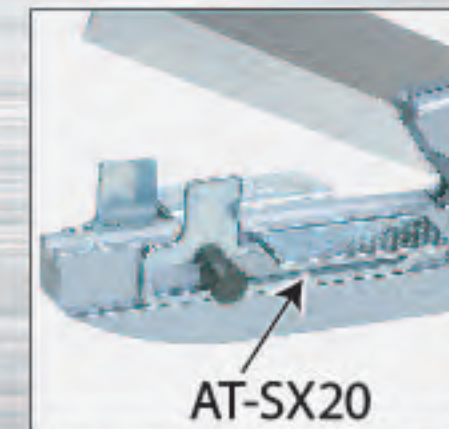

AT-SX20
An attachment is available, for right and 45° angle cutting. (Standard accessory)



Cutting of nylon hoses

Model	Overall length (mm)	Weight (g)	Blade length (mm)	Blade	Plastic plate
SX20	285	685	110	X20	PB-SX20-5P

SX25

< Long blade type >

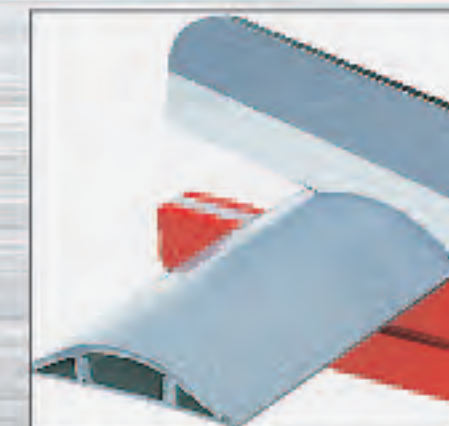
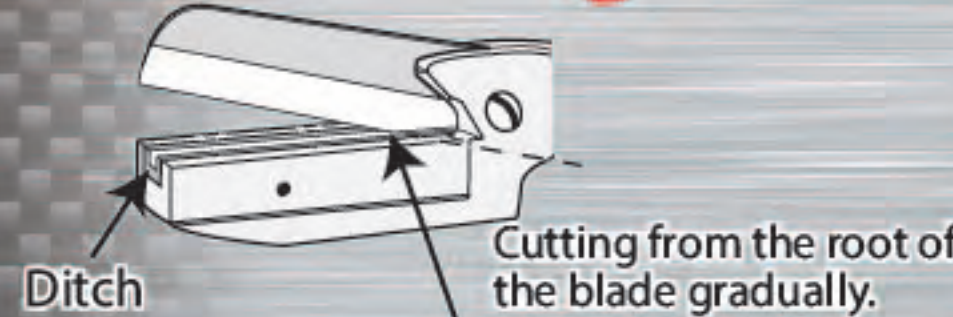

Cutting flat and wide cable protector.



AT-SX20
An attachment is available, for right and 45° angle cutting. (standard accessory)

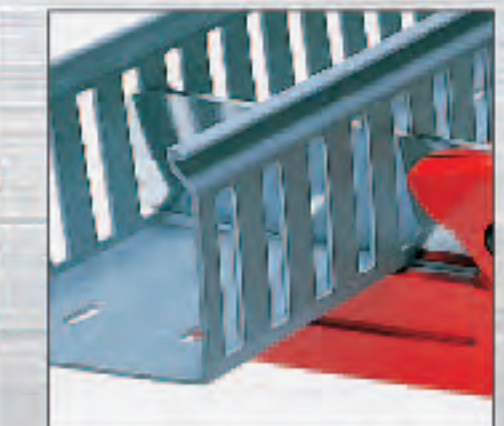

Cutting plastic duct of up to 80mm in width.

Model	Overall length (mm)	Weight (g)	Blade length (mm)	Blade	Plastic plate
SX25	285	685	110	X25	PB-SX25-5P

Examples of subjects for cutting

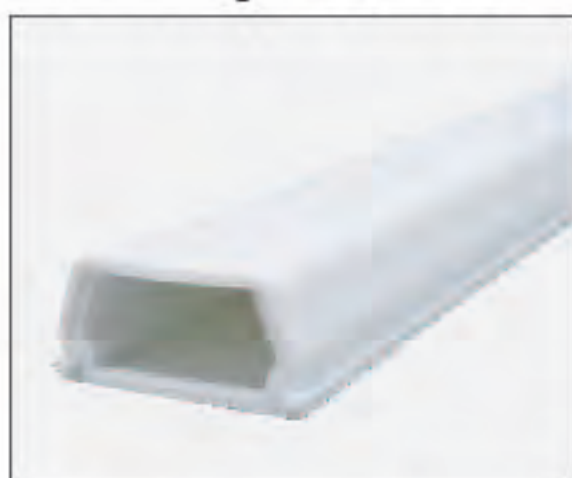

■ Protector



■ Nylon hose



■ Electric wire (Twisted wire)



■ Tree branch



■ Plastic cable protector

DUCT AND MOULD CUTTERS/ MERRY CUTTERS

Section of blade

Round type

Flat type

Angle type

DX80

< Ratchet type >



AT-DX71

3-step ratcheting

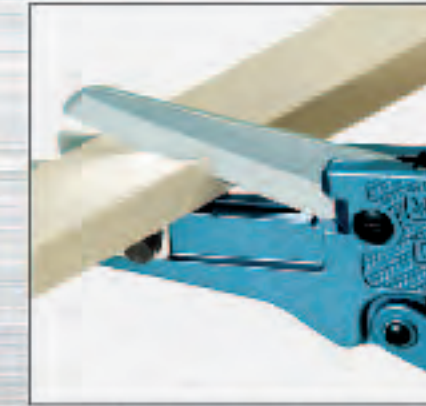
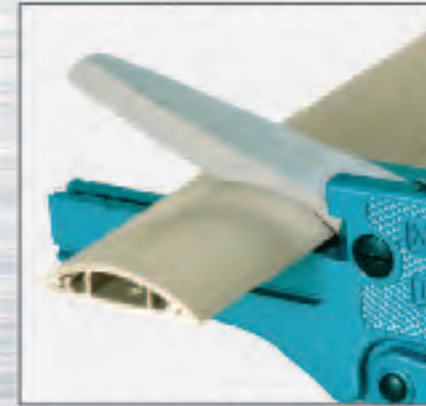

Cutting cable protector An attachment is available, for right and 45° angle cutting.(standard accessory)
Cutting plastic duct of up to 80mm in width

Model	Overall length (mm)	Weight (g)	Blade length (mm)	Blade
DX80	255	470	92	X80

LDC110

< Long duct cutter >



AT-LDC110

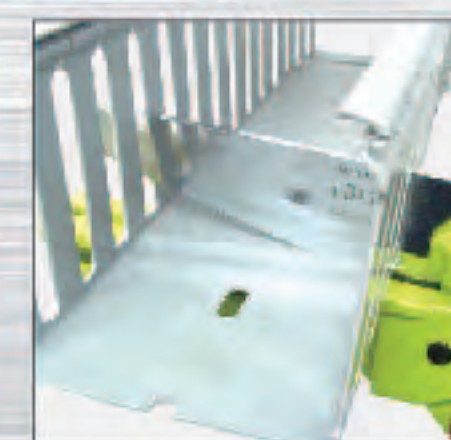

Model	Overall length (mm)	Weight (g)	Blade
LDC110	322	700	LD110

DRN4

< DIN Rail Round Nipper >

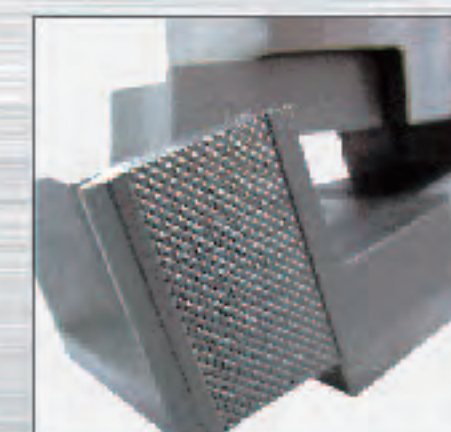
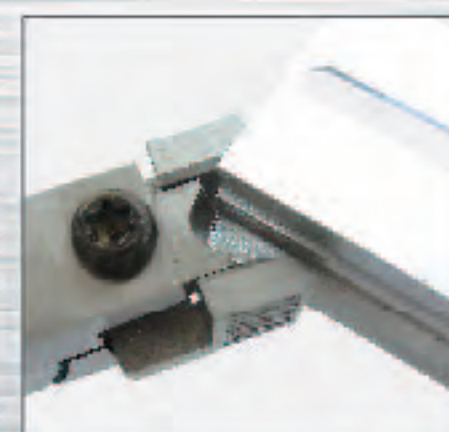
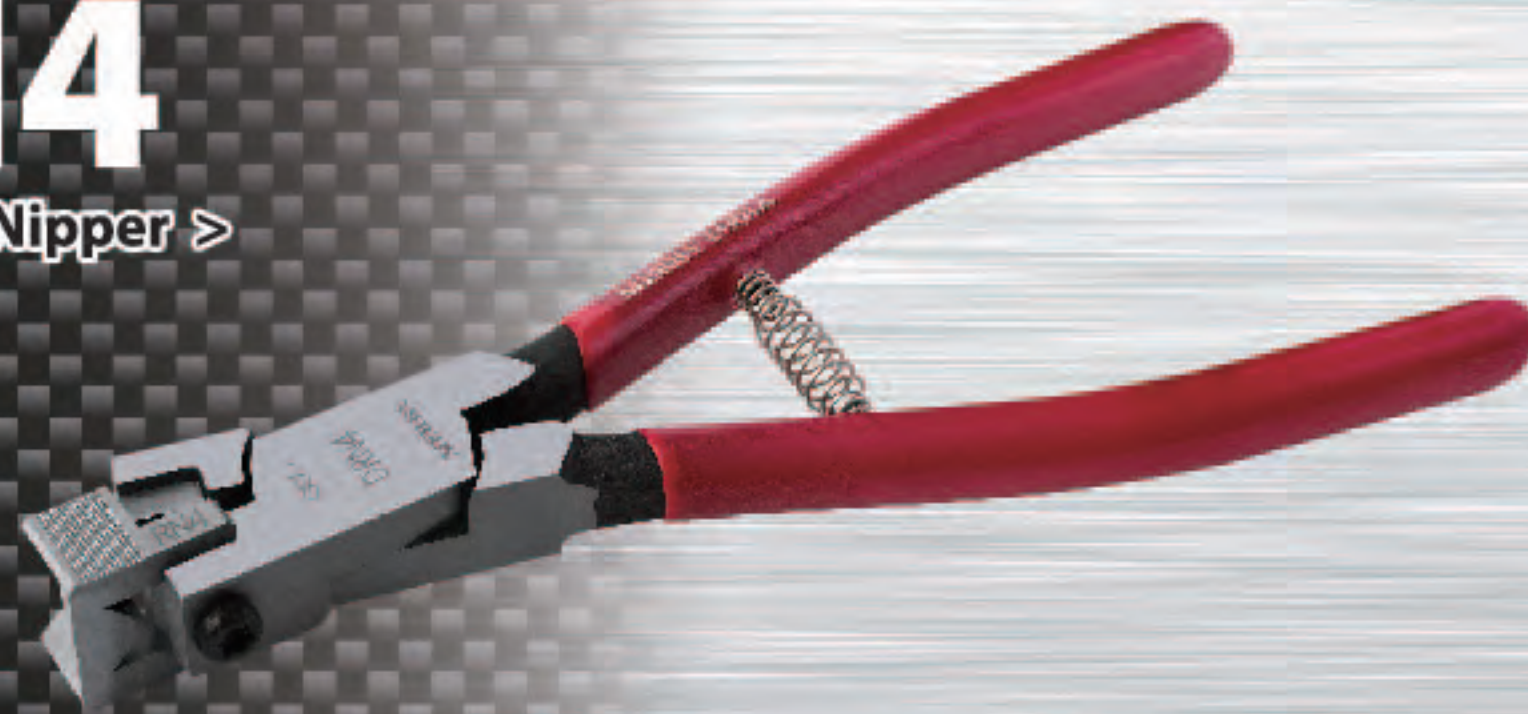

Model	Overall length (mm)	Weight (g)	Blade
DRN4	200	350	RN4

TDC100



Compact design

Duct widths up to 100mm

Safety pin attached

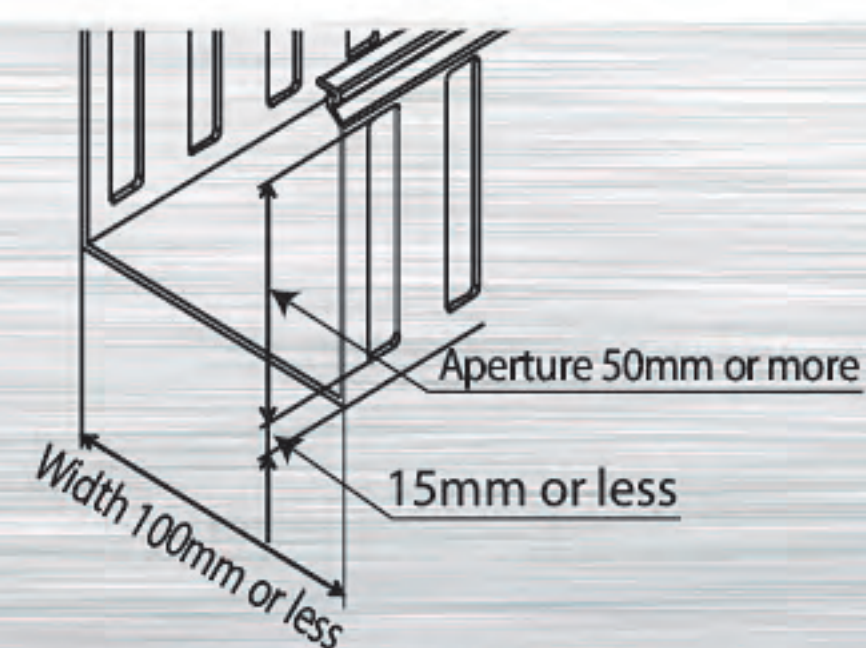

Model	Overall length (mm)		Weight (kg)	Blade length (mm)	Blade
	a	b			
TDC100	300	200	8.4	110	TD100

DK55 DK65

< End cutting type >

Spring Loaded

Round type

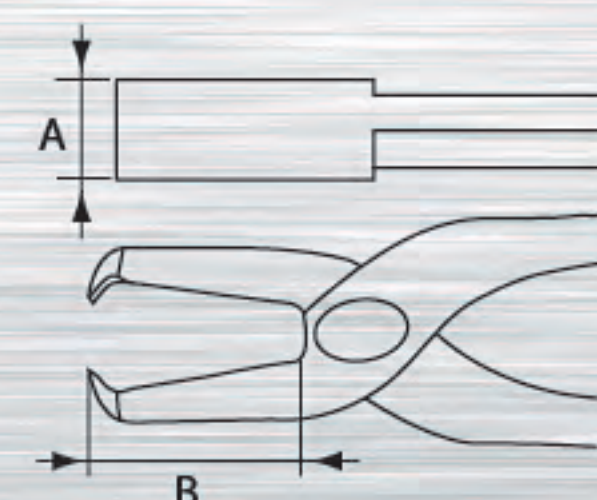

Model	Size (mm)	Dimensions (mm)		Weight (g)	Cutting capacity (φmm) Plastics
		A	B		
DK55	250	21.5	55.0	530	8.0
DK65	250	21.5	65.0	505	8.0